

Руководство по эксплуатации

Полноприводная радиоуправляемая машина с нитро-двигателем в масштабе 1/10

RH1006 SPIRIT N1 (Single Speed)

Характеристики RH1006:

1. Длина: 415 мм (MT)
2. Ширина: 255 мм (MT)
3. Высота: 142 мм (MT)
4. Колесная база: 275/280 мм
5. Передаточное число: 9.1:1
6. Шины: Ø 88*34 мм (Перед.)
Ø 88*39 мм (Задн.)
7. Вес: 1840 г (Spirit)

Стандартное оборудование:

1. Рулевой сервопривод: 3 кг/см
2. Сервопривод тяги: 3 кг/см
3. Двигатель: GO.18 или SH.18
4. Радио: 2 канала AM

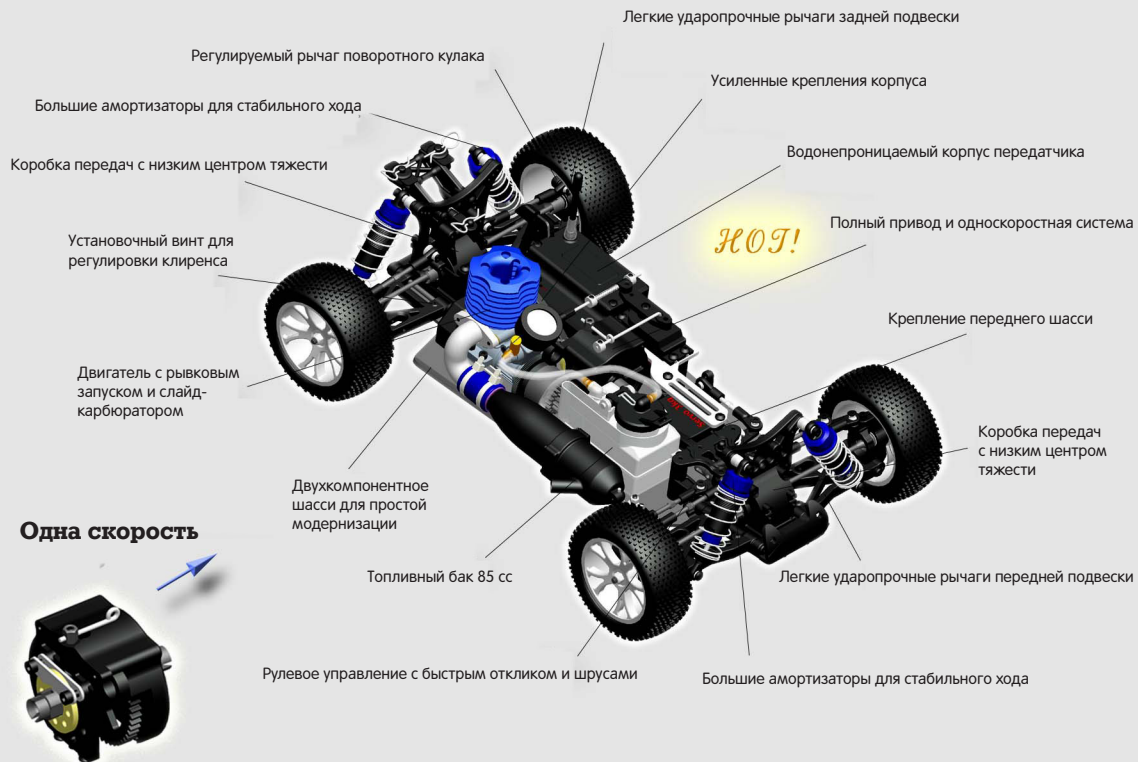

RH1007 SPIRIT N2 (Two Speed)

Характеристики RH1007:

1. Длина: 415 мм
2. Ширина: 255 мм
3. Высота: 142 мм
4. Колесная база: 275/280 мм
5. Передаточное число: 6.1:1 (Выс)
9.1:1 (Низк)
6. Шины: Ø 88*34 мм (Передн.)
Ø 88*39 мм (задн.)
7. Вес: 1900 г (Spirit N2)
1850 г (ST)

Стандартное оборудование:

1. Рулевой сервопривод: 3 кг/см
2. Сервопривод тяги: 3 кг/см
3. Двигатель: GO.18 или SH.18
4. Радио: 2 канала AM

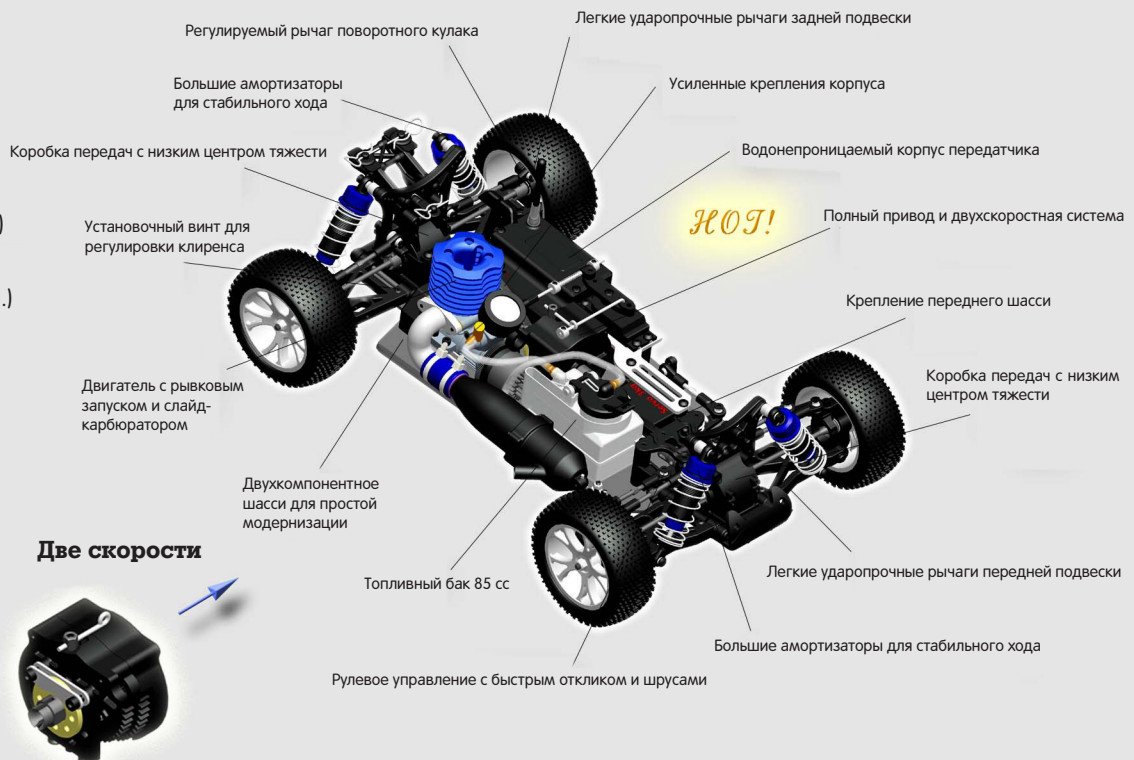

СБОРКА ПЕРЕДНИХ И ЗАДНИХ АМОРТИЗАТОРОВ

Передние амортизаторы

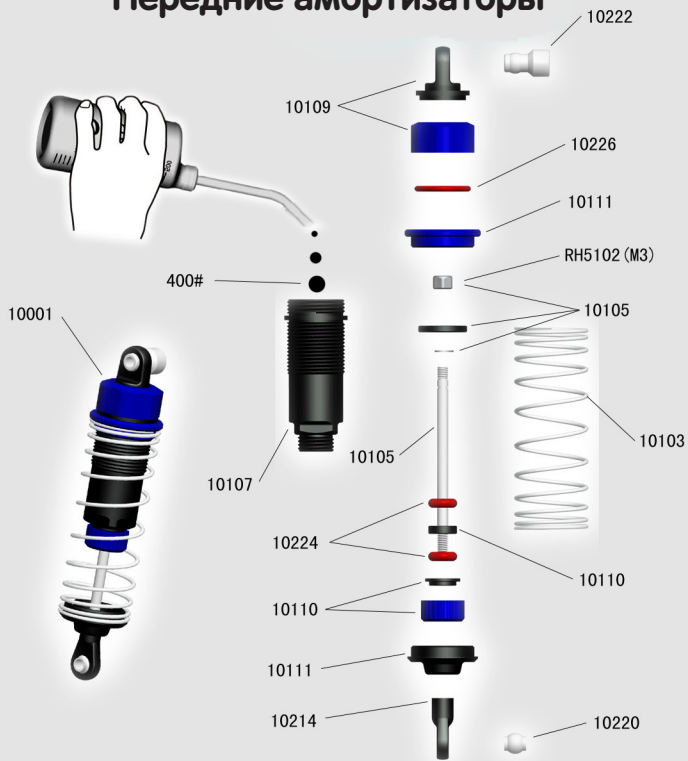

(Схема 1-1)

Задние амортизаторы

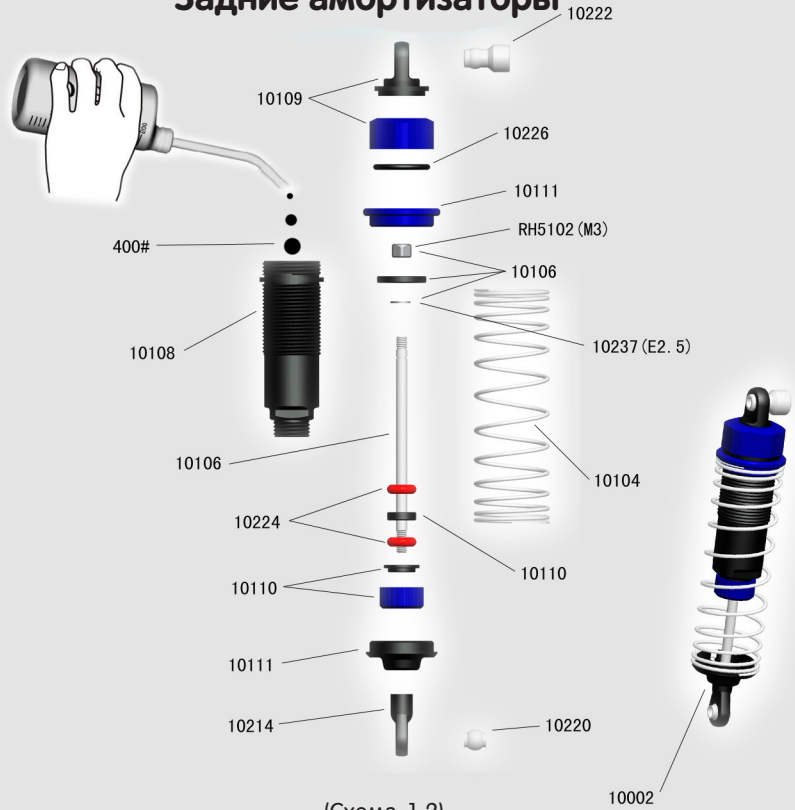

(Схема 1-2)

Сборка шасси

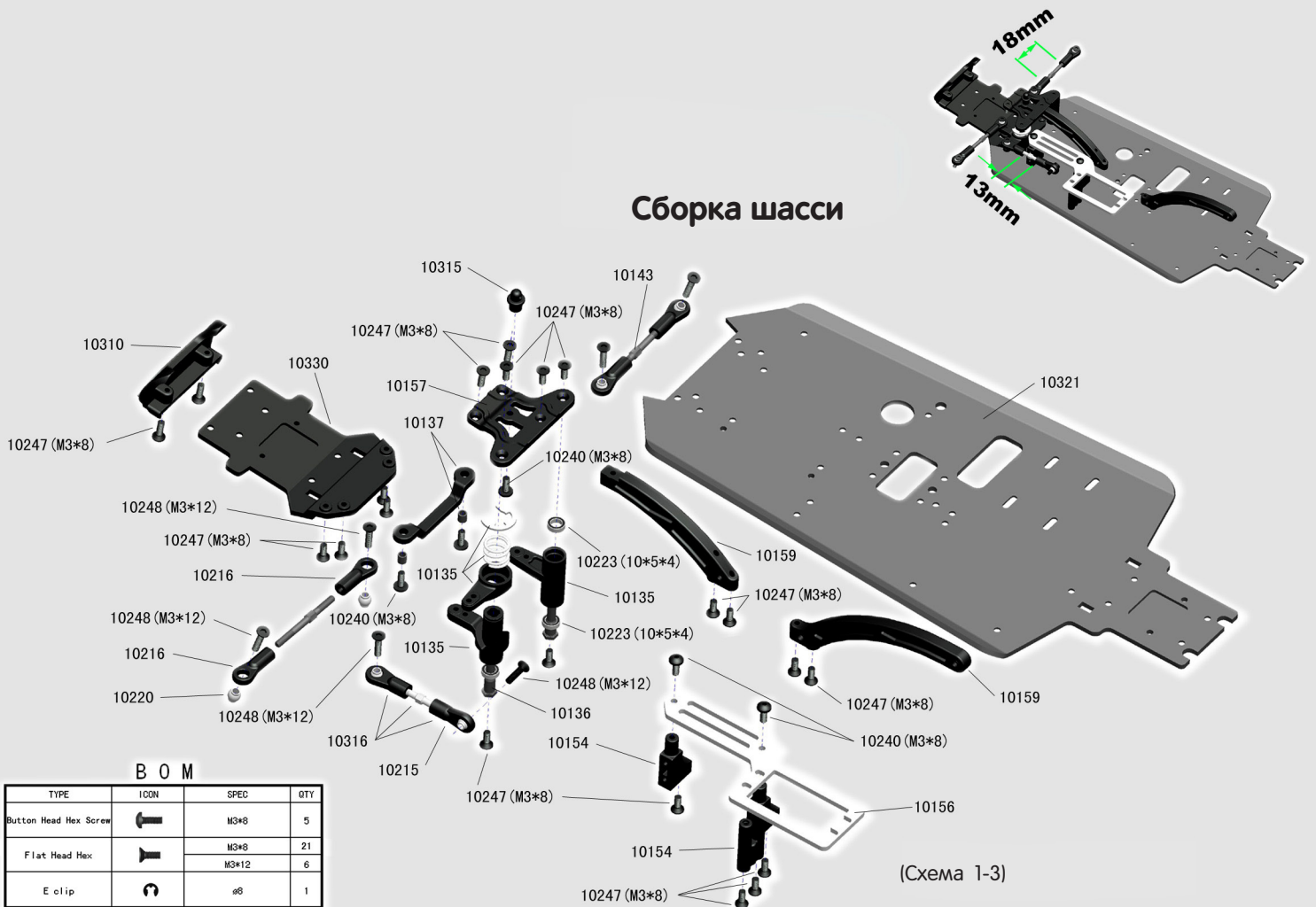

(Схема 1-3)

B O M

TYPE	ICON	SPEC	QTY
Button Head Hex Screw		M3*8	5
Flat Head Hex		M3*8	21
		M3*12	6
E clip		ø8	1
Ball Bearing		ø8*ø5*2.5	3

B O M

TYPE	ICON	SPEC	QTY
Round Head Self Tapping Hex Screw		2*10	4
Button Head Hex Screw		M3*12	2
Cap Head Hex Screw		M3*8	4
		M3*18	2
		M3*10	10
		M3*12	3
		M3*14	4
		M3*18	2
		M3*36	2
		M3*3	2
		M4*4	1
		M4*10	2
Ring Self Tapping Screw		3*4	2
Washer		ø6*ø3.1*0.2	2
Nylon Lock Nut		M3	2
E clip		ø2.5	5
O'Ring		ø8.05*ø4.95*ø1.55	4
		ø8*ø3*ø2.5	4
		ø15.6*ø12.6*ø1.5	2
Ball Bearing		ø15*ø10*4	2
		ø10*ø5*4	6

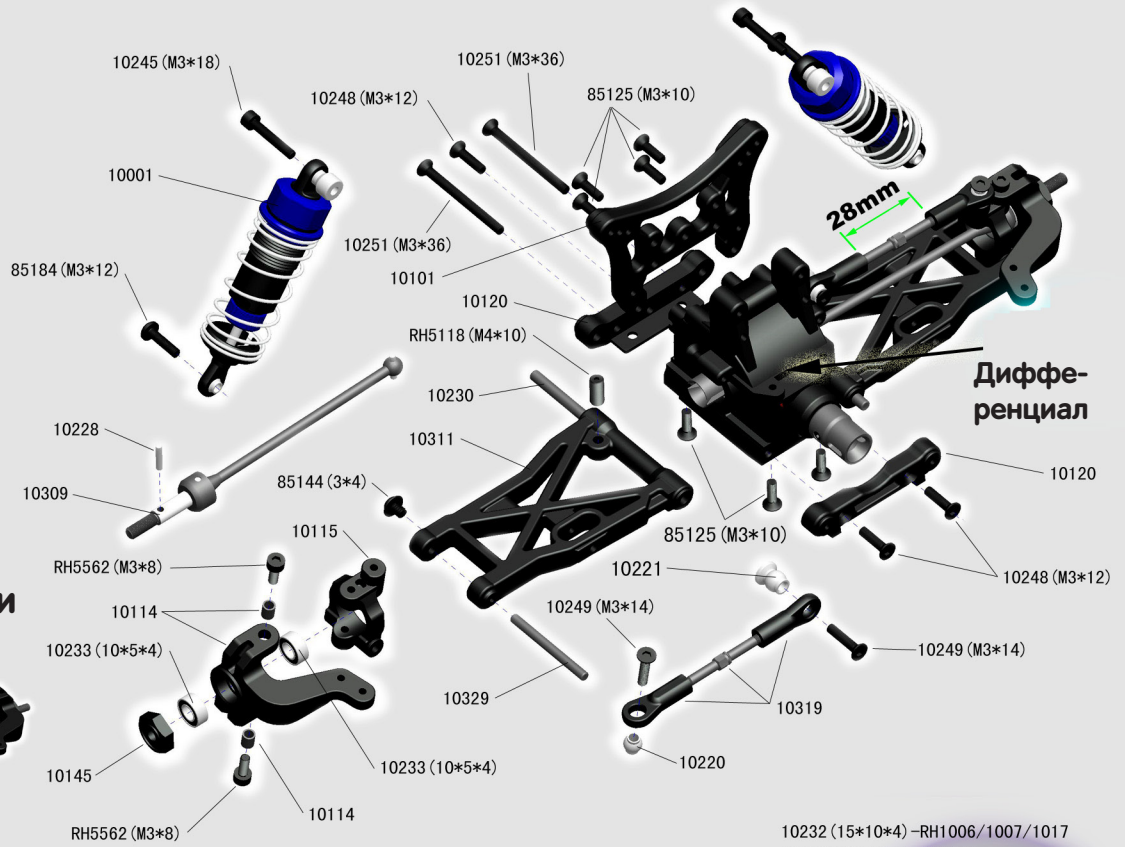

Дифференциал

Сборка передней части

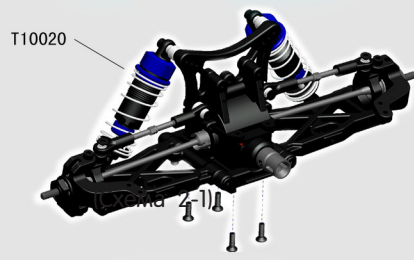

Сборка дифференциала

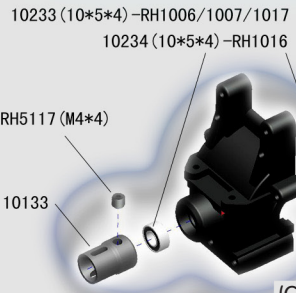

(Схема 2-2)

Коробка дифференциала

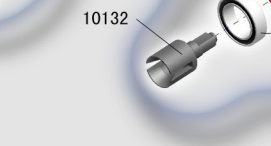

(Схема 2-3)

Коробка дифференциала



Сборка задней части

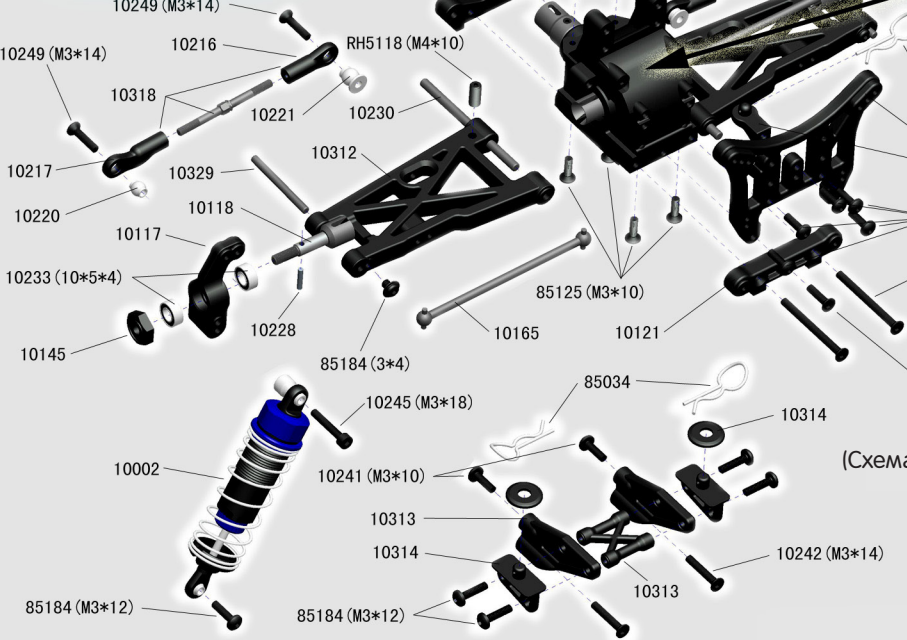

(Схема 2-4)

Сборка дифференциала

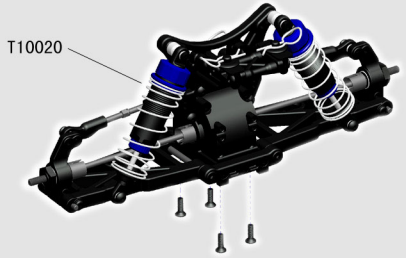

B O M

TYPE	ICON	SPEC	QTY
Round Head Self Tapping Hex Screw		2*10	4
Button Head Hex Screw		M3*8	2
		M3*12	6
		M3*18	2
Cap Head Hex Screw		M3*25	1
		M3*10	4
		M3*12	3
		M3*14	4
		M3*18	4
		M3*36	2
		M4*4	1
		M4*10	2
Ring Self Tapping Screw		3*4	2
Washer		ø6*ø3.1*0.2	2
Nylon Lock Nut		M3	3
E clip		ø2.5	5
O'Ring		ø8.05*ø4.95*ø1.55	4
		ø8*ø3*ø2.5	4
		ø15.6*ø12.6*ø1.5	2
Ball Bearing		ø15*ø10*4	2
		ø10*ø5*4	6

В О М

TYPE	ICON	SPEC	QTY
Round Head Self Tapping Hex Screw		2*6	4
Button Hex Screw		M3*8	4
Cap Head Hex Screw		M3*15	2
		M3*28	5
Flat Head Hex		M3*10	1
Set Screw		M4*4	1
Washer		φ6*φ3.1*0.2	1
Nylon Lock Nut		M3	5
O' Ring		φ31* φ2	1
Ball Bearing		φ10*φ5*4	2

Сборка двигателя

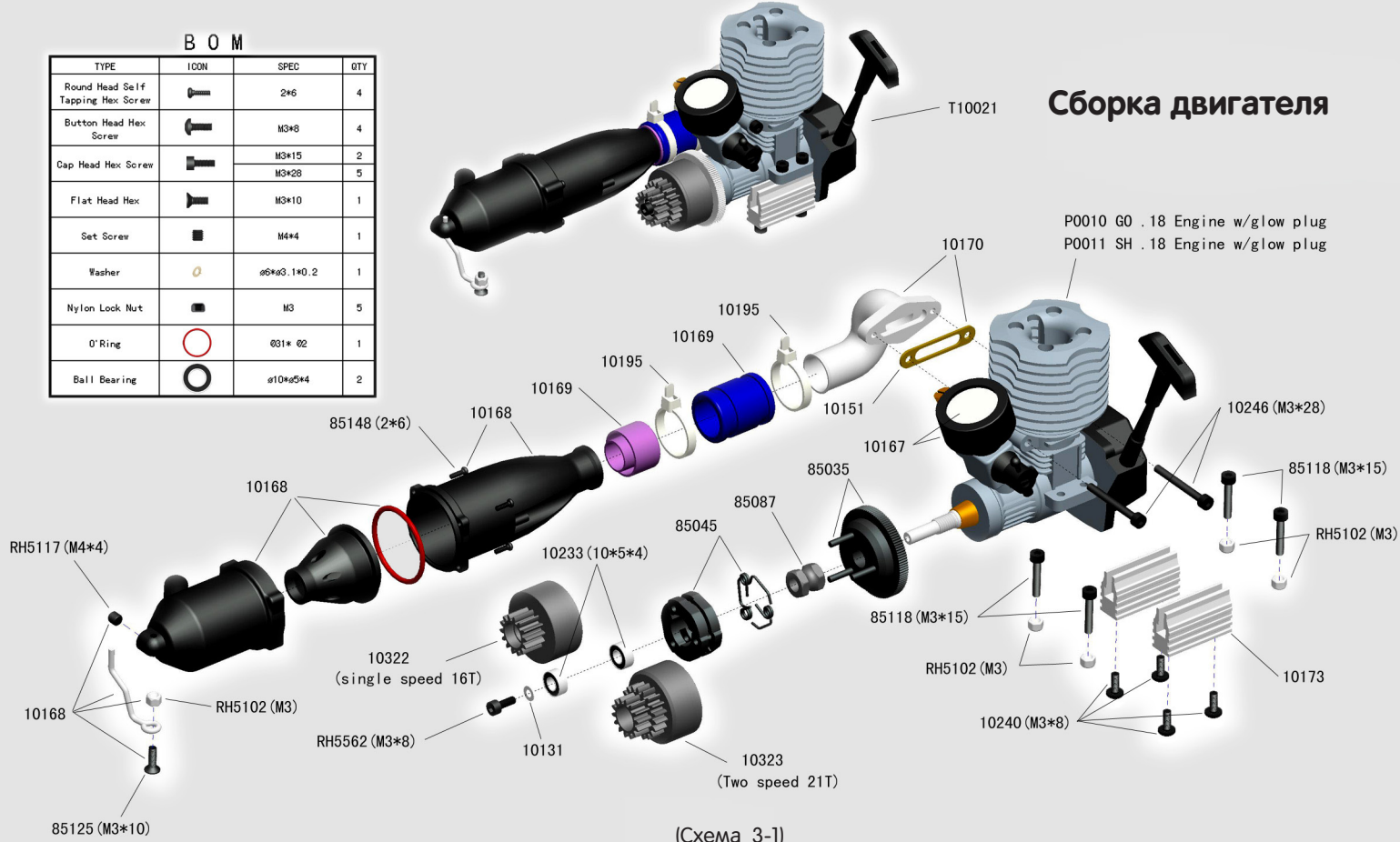

Центральная трансмиссия BladeSS

В О М

TYPE	ICON	SPEC	QTY
Cap Head Hex Screw		M3*10	2
Flat Head Hex		M3*8	4
		M3*20	2
Set Screw		M3*3	1
E clip		φ4	3
		φ4	3
Ball Bearing		φ10*φ5*4	2

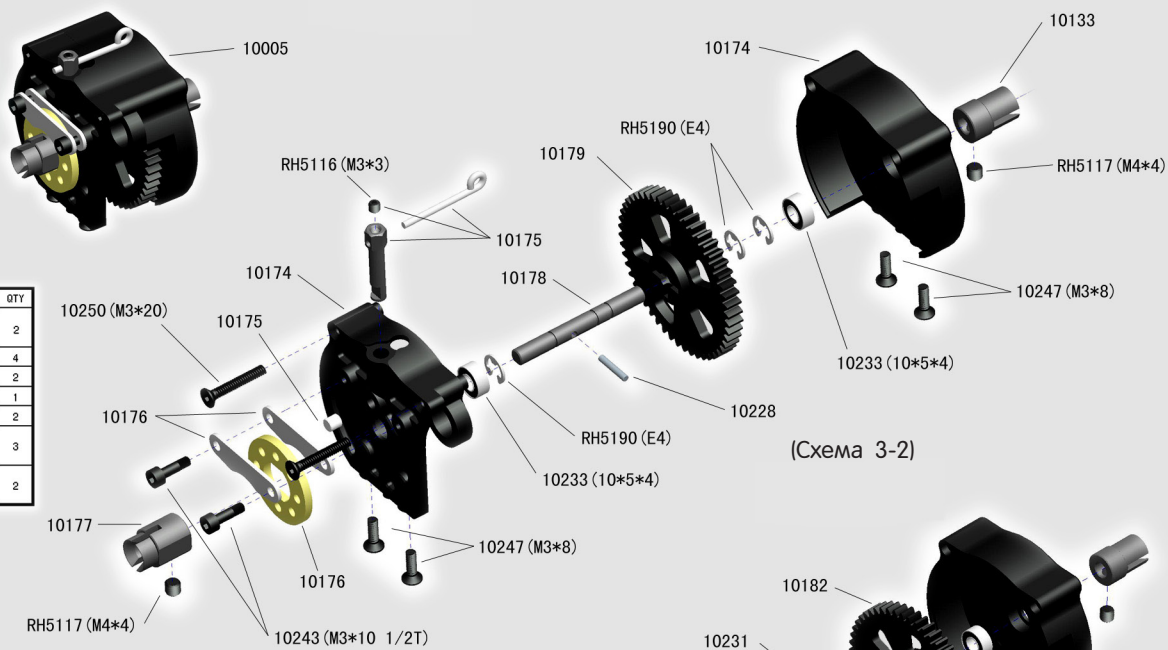

Центральная трансмиссия BladeTS

В О М

TYPE	ICON	SPEC	QTY
Cap Head Hex Screw		M3*10	2
Flat Head Hex		M3*8	4
		M3*20	2
Set Screw		M3*3	1
		M4*4	4
E clip		φ4	1
One Way Bearing		φ12*φ6.3*8.4	1
Ball Bearing		φ10*φ5*4	3

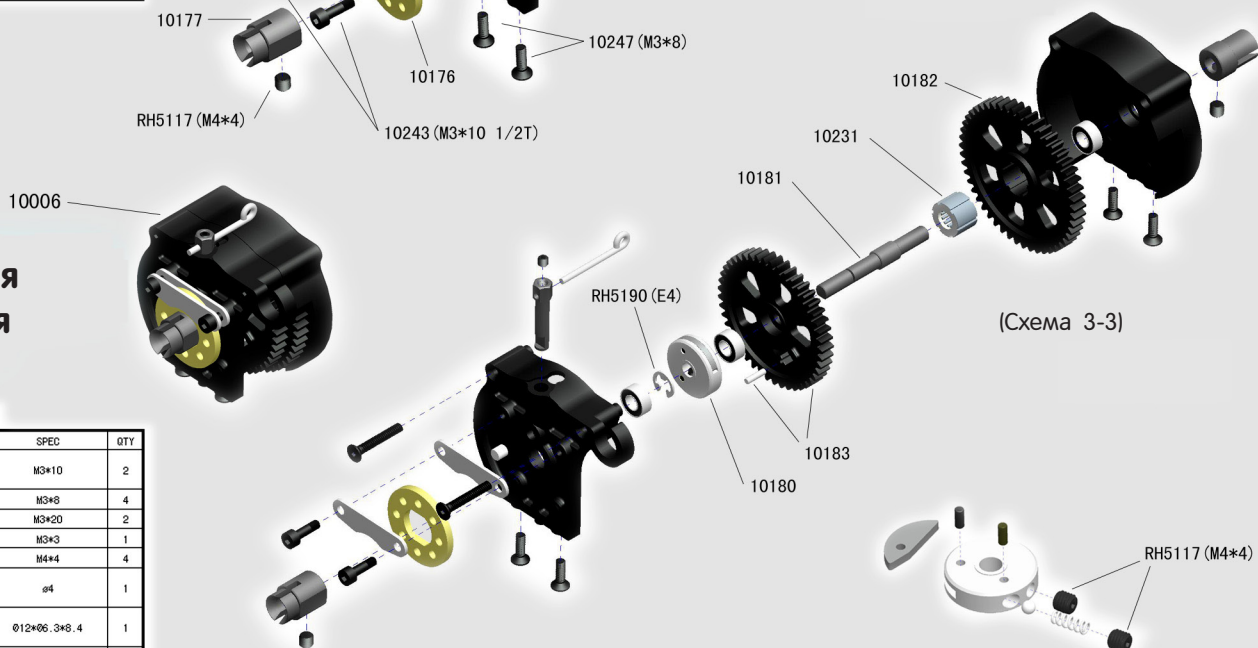

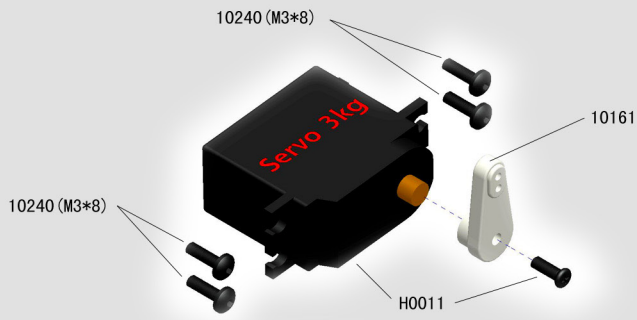

Рулевой сервопривод



(Схема 4-1)

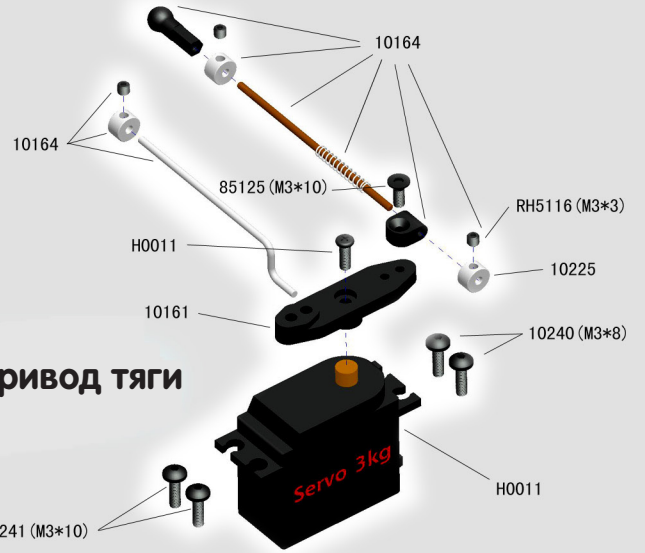

Сервопривод тяги



(Схема 4-2)

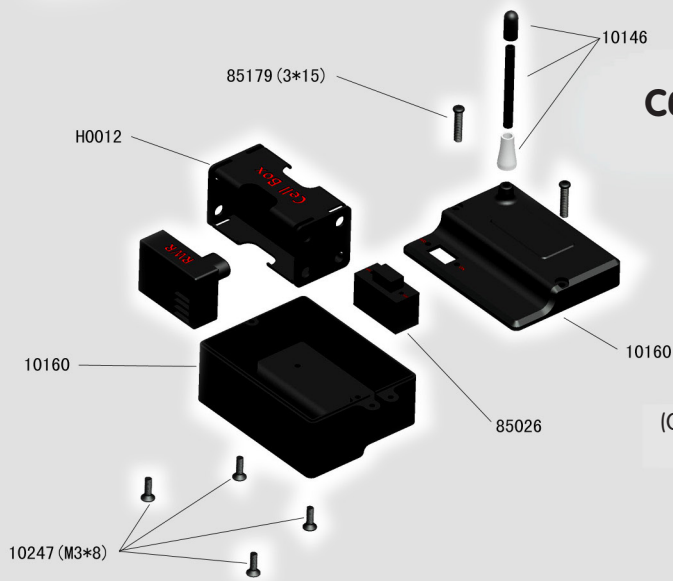

Сборка приемника



(Схема 4-3)

Колеса МТ



(Схема 4-4)

Колеса СТ

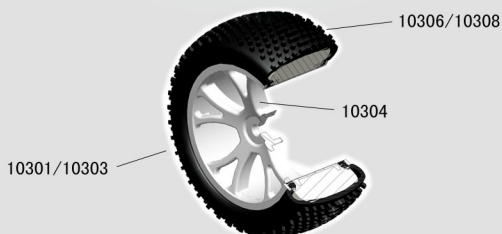

(Схема 4-5)

Топливный бак

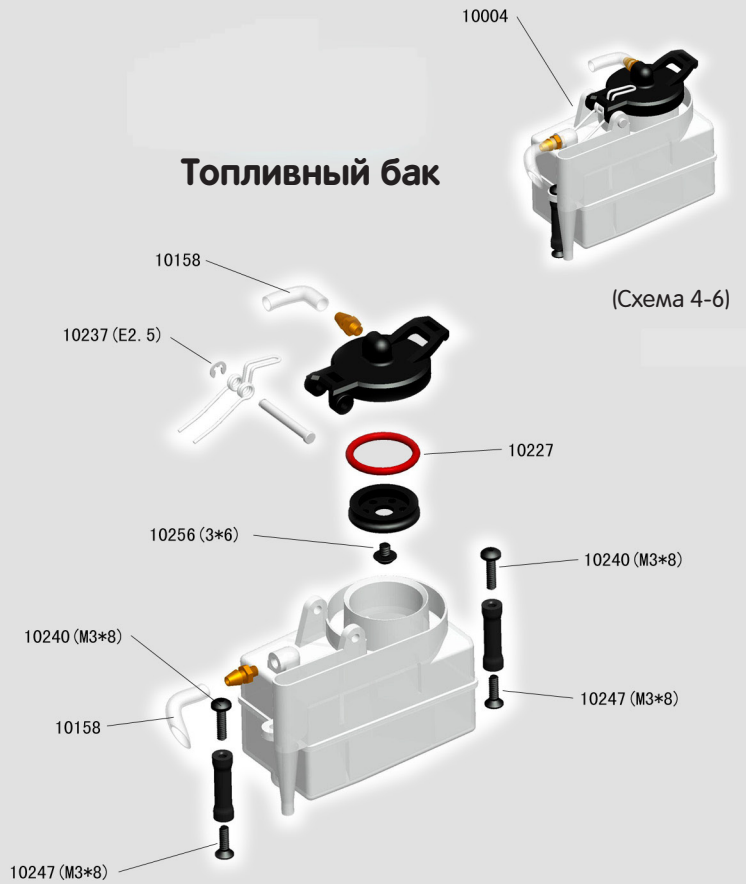

(Схема 4-6)

SpiritN1 и SpiritN2 имеют практически одинаковую структуру, различаются только центральные трансмиссии (см.Схема 3-2 и Схема 3-3). Для людей, увлеченных своим хобби, мы создали дополнительные передние и задние стабилизаторы, которые улучшают ходовые характеристики при гонках, Дополнительный Передний и Задний Стабилизатор #10324.

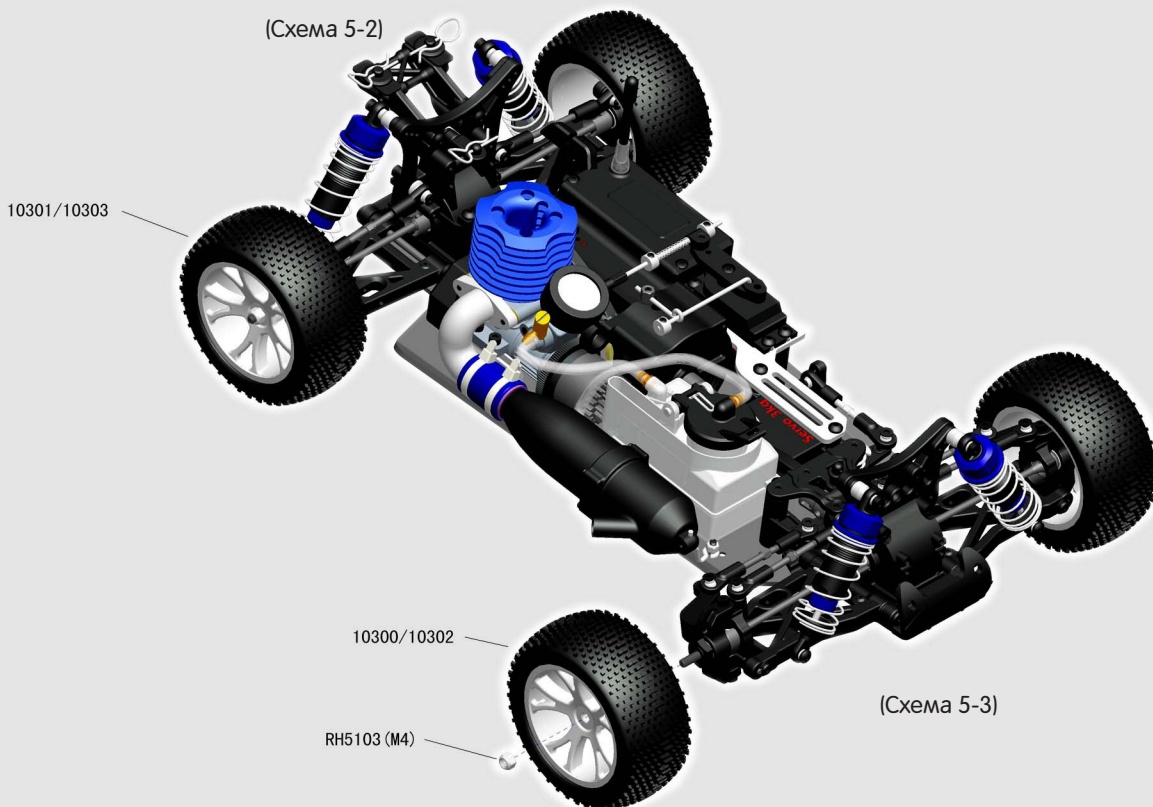
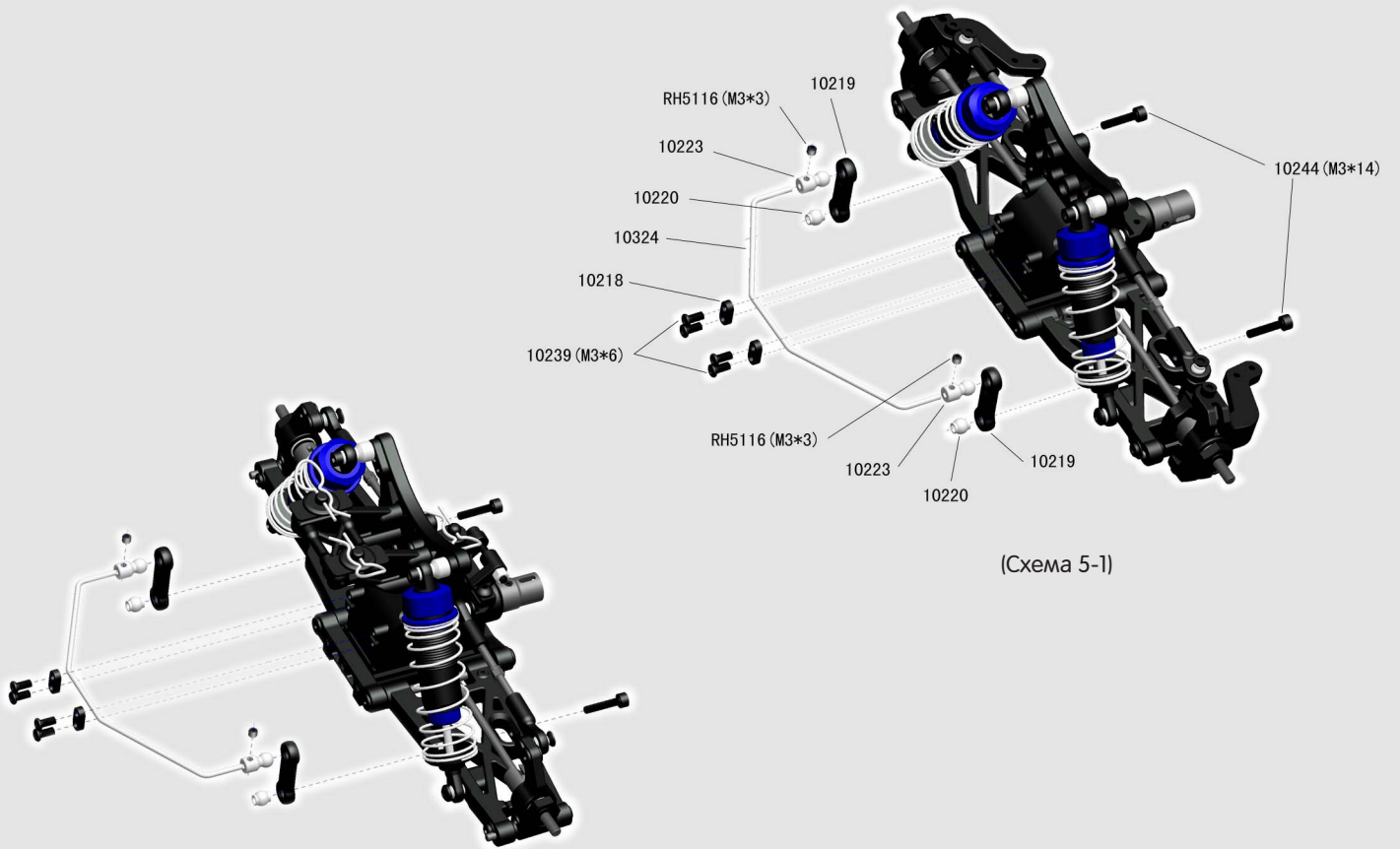

(Схема 5-3)

Этапы сборки:

1. Подсоедините стойки топливного бака к шасси, затем соберите топливный бак (см. Схема 4-6)

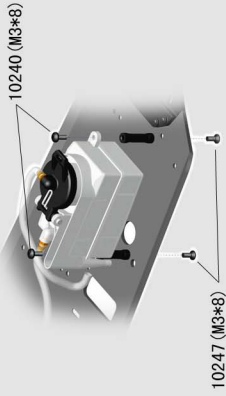

2. Соберите шасси (см. Схема 1-3)



3. Прикрепите к шасси собранную переднюю часть (см. Схема 2-1)

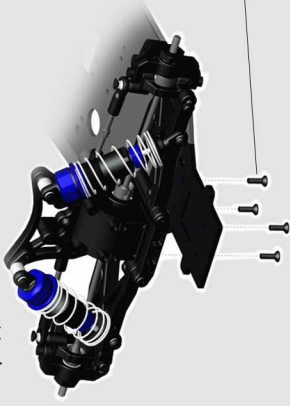

4. Прикрепите к шасси собранную заднюю часть (см. Схема 2-4)

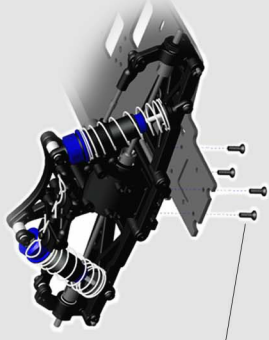

5. Прикрепите колеса (см. Схема 4-4 или 4-5)



6. Прикрепите собранную центральную трансмиссию и задний центральный приводной вал к шасси (см. Схема 3-2 или 3-3)

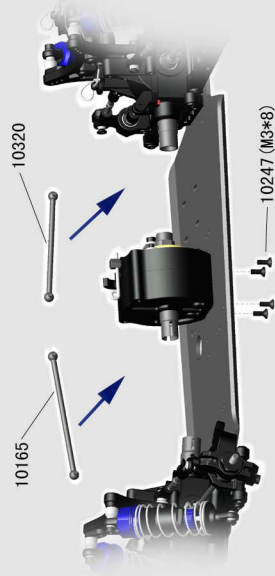

7. Подсоедините собранный двигатель к шасси (см. Схема 3-1)

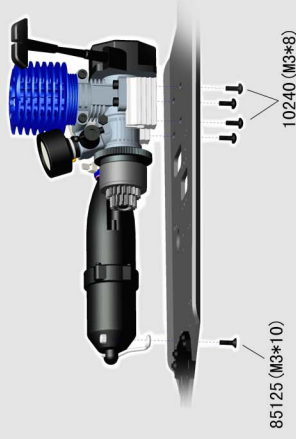

8. И, наконец, подсоедините к шасси коробку приемника, сервоприводы тяги и рулевого управления. Затем настройте систему радиоуправления, после чего прикрепите сверху штампованный корпус к соответствующим креплениям (см. схема 4-1, 4-2, 4-3)

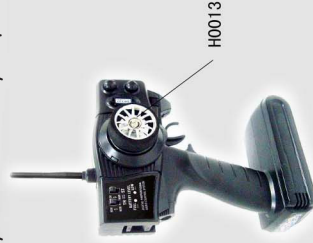
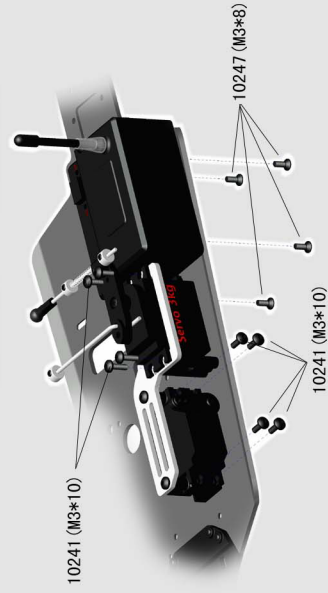

85034

Руководство по эксплуатации

Полноприводный электрический багги в масштабе 1/10

RH1016 SPIRIT EBD (Brushed)

RH1017 SPIRIT EBL (Brushless)

Характеристики:

1. Длина: 415 мм
2. Ширина: 255 мм
3. Высота: 142 мм
4. Колесная база: 275/280 мм
5. Передаточное число: 8.3:1
6. Шины: Ø 88*34 мм (перед.)
Ø 88*39 мм (задн.)
7. Вес: 1710 г (Spirit EBD)
1650 г (Spirit EBL)

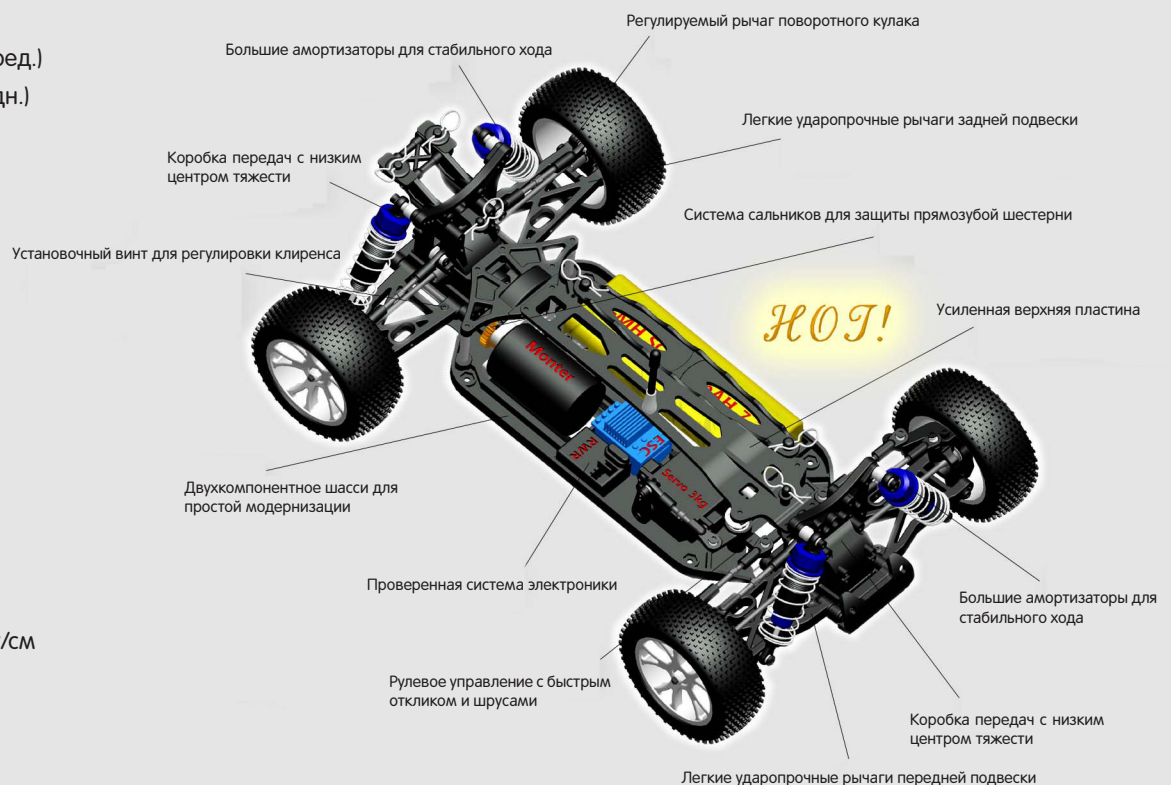

Стандартное оборудование:

1. Рулевой сервопривод: 3 кг/см
2. Мотор: 550 (Spirit EBD)
3650 (Spirit EBL)
3. ESC: 300A (Spirit EBD)
60A (Spirit EBL)
4. Батарея: Ni-MHSC1800 mAh 7.2V (Spirit EBD)
Li-Po 2700 mAh 7.4V ≤25C 3650 (Spirit EBL)
5. Радио: 2 канала AM (Spirit EBD)
2 канала 2.4 ГГц (Spirit EBL)

Набор для бесщеточной системы Spirit EBL

Набор для щеточной системы Spirit EBD



SpiritEBDi SpiritEBL переделаны из SpiritN1 и у них такая же передняя часть (см. Схема 2-1). Задняя часть в точности такая же, как у SpiritN1, и отличается только отсутствием крышки центральной полуоси (см. Схема 7-2).
 Внимание: SpiritEBDi SpiritEBL отличаются только по ESC, батареемотора, зарядному устройству и радиоуправлению.

Сборка центральной части

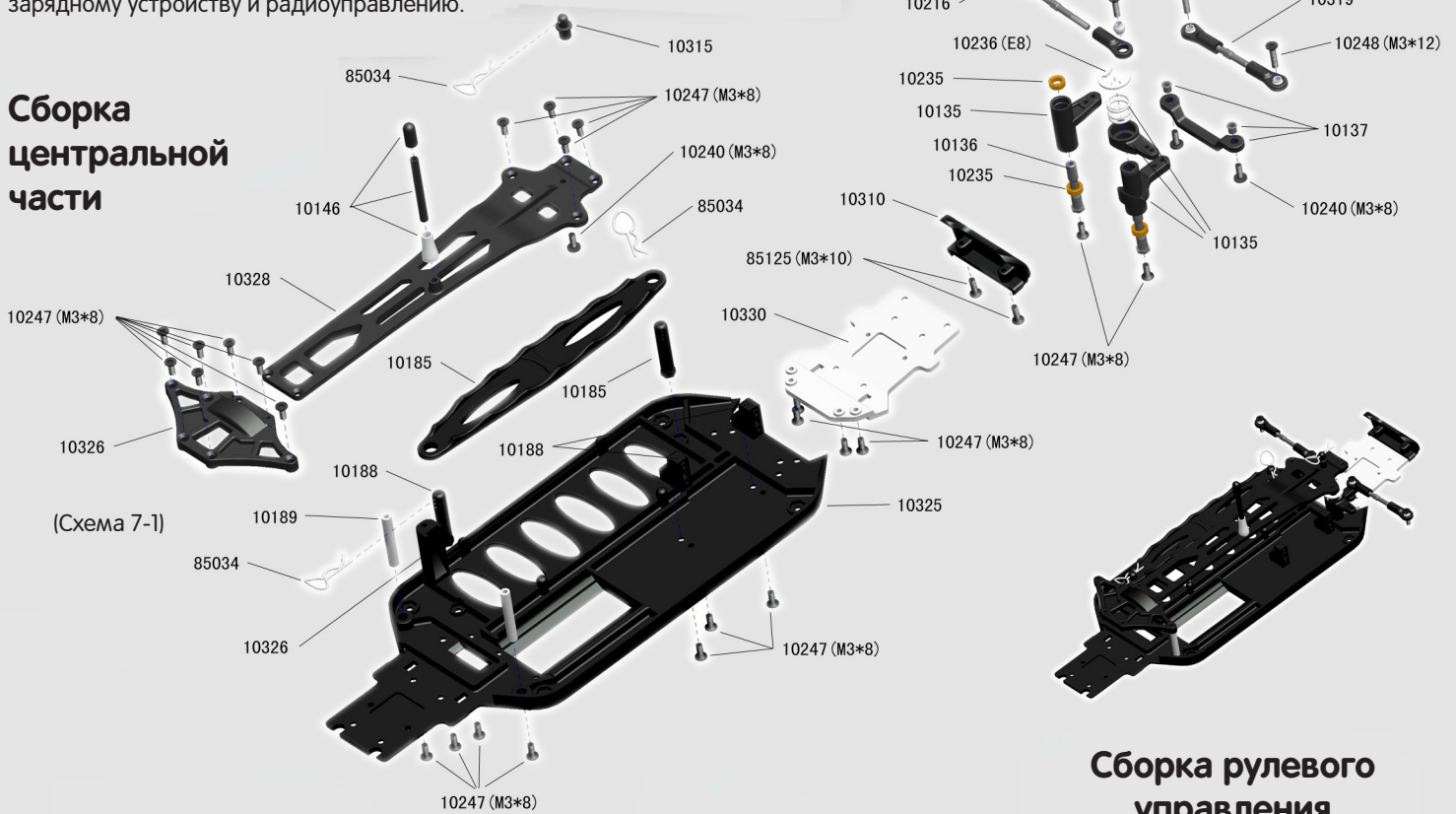

Сборка задней части



ESC

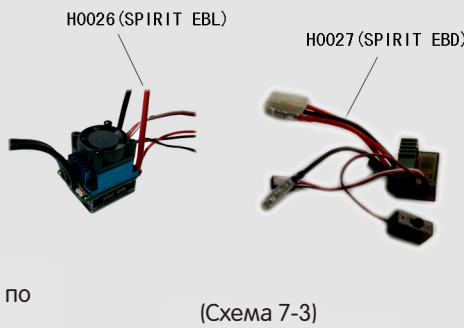

Сборка рулевого управления

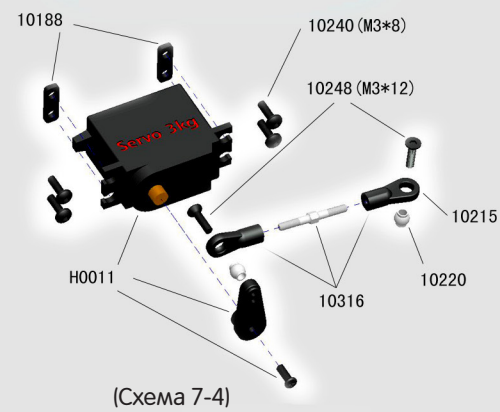

Сборка мотора

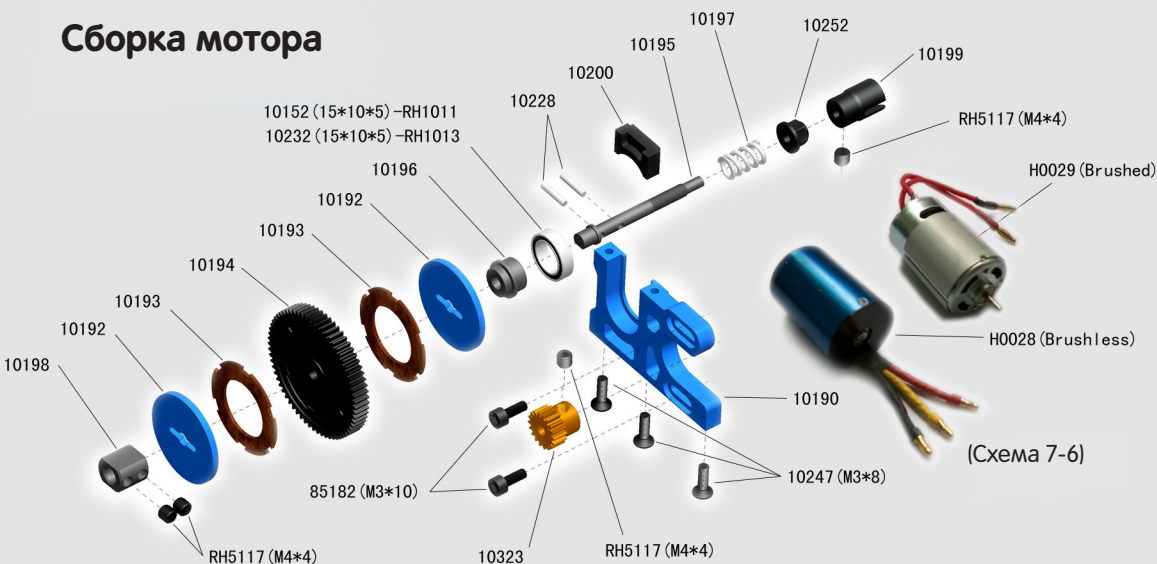

Приемник

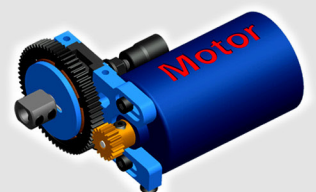

(Схема 7-6)

(Схема 7-5)

(Схема 7-2)

(Схема 7-3)

(Схема 7-4)

SpiritEBDi SpiritEBLотличаются только системой электроники.SpiritEBD поставляется со щеточной системой, аSpiritEBL– с бесщеточной. Для людей, увлеченных своим хобби, мы создали дополнительные передние и задние стабилизаторы, которые улучшают ходовые характеристики при гонках.

Для схем сборки других частей – обратитесь к инструкциям для SpiritN1на странице 7 и далее.

Дополнительный Передний и Задний Стабилизатор #10324.

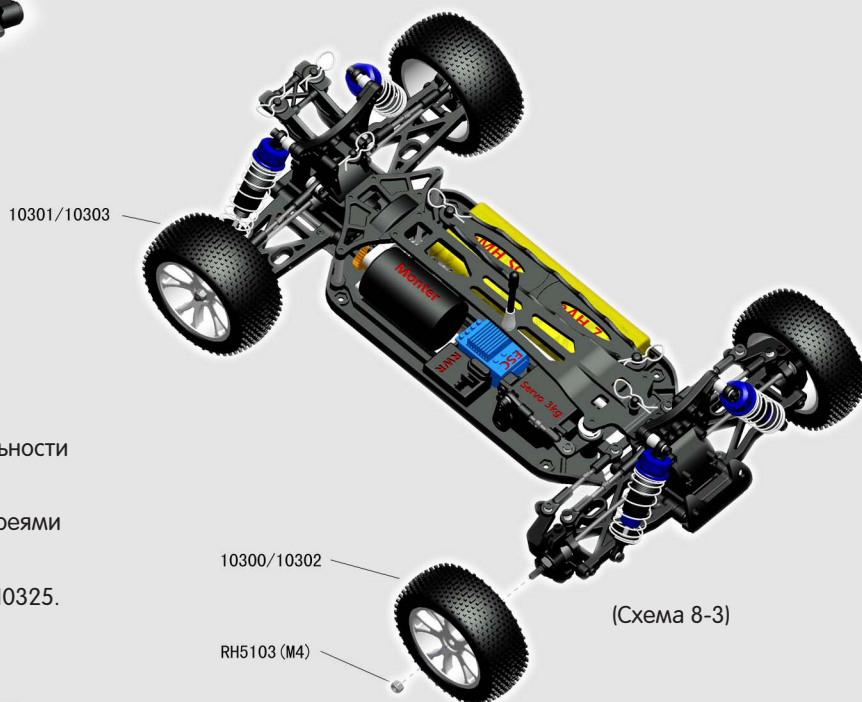
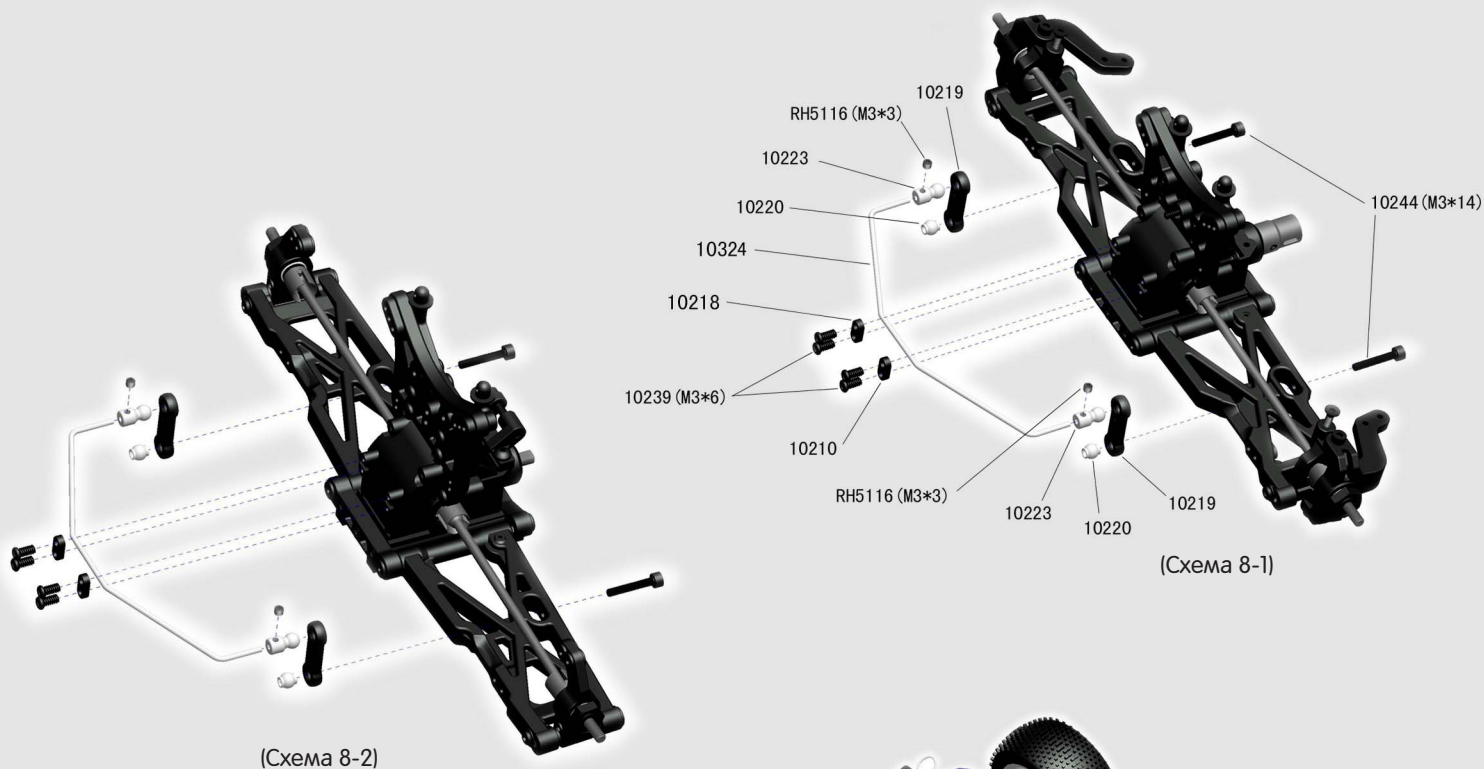

КОМПЛЕКТ ДЛЯ ЕЗДЫ НА ЗАДНИХ КОЛЕСАХ:

Мы создали данный комплект для повышения стабильности управления на максимальных скоростях для «супер-игроков», которые управляют машиной с 3SLi-Po батареями и гоняют с приподнятой передней частью.

Дополнительный Передний и Задний Стабилизатор #10325.

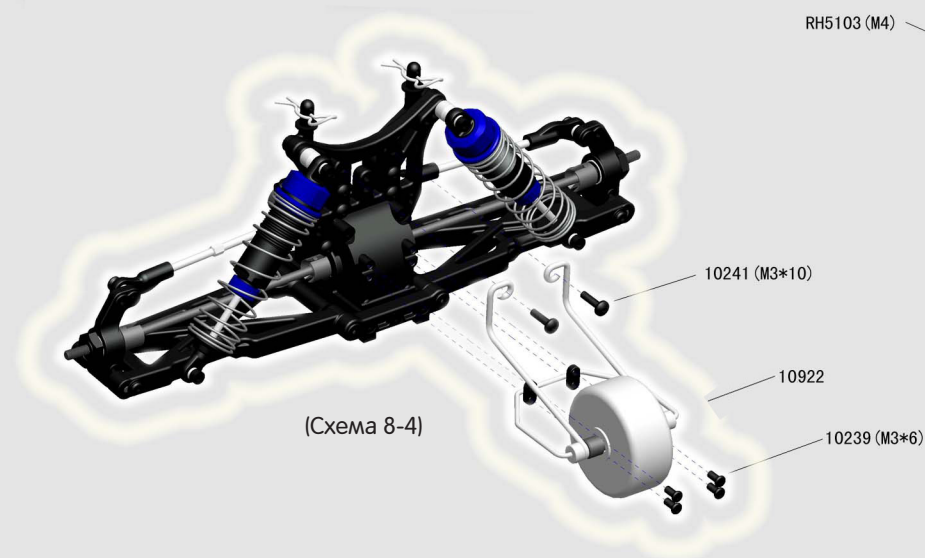

Этапы сборки:

1. Соберите центральную часть шасси (см. Схема 7-1)



2. Прикрепите к шасси собранную переднюю часть (см. Схема 2-1)

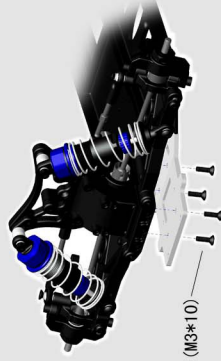

85125 (M3*10)

3. Прикрепите к шасси собранную заднюю часть (см. Схема 2-4)



85125 (M3*10)

4. Установите колеса (см. Схема 4-4, 4-5)



RH5103 (M4)

5. Установите собранный мотор и центральный приводной вал (см. Схема 7-6)

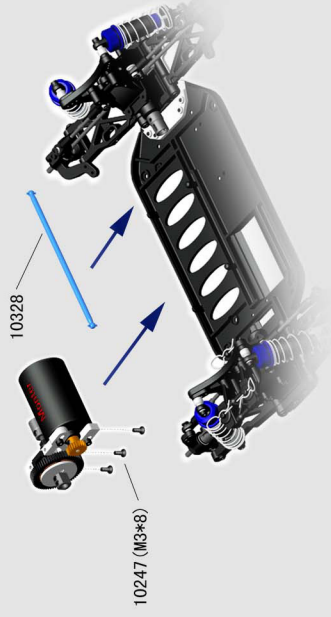

10247 (M3*8)

10328

6. Подсоедините рулевой сервопривод и тяги (см. Схема 7-4)



10240 (M3*8)

8. Соберите ESC, приемник, батарею и соедините их (см. Схема 7-3, 7-5).

Бесщеточная система

H0014



85274

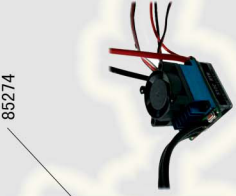

Щеточная система

H0013



H0030



R0069/R0072/R0073















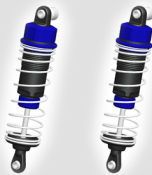
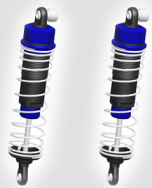

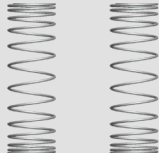

R0075/R0076/R0077

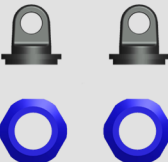
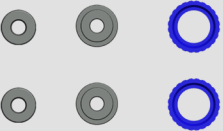
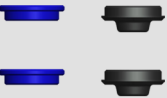

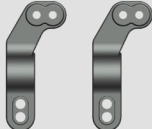
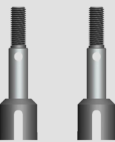

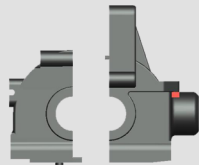

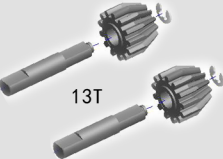
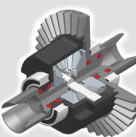





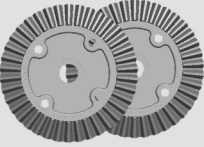
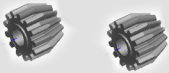
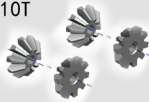
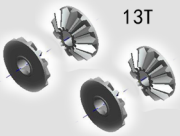

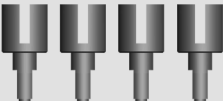

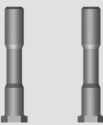



85034



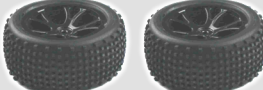









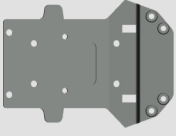

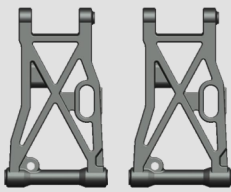
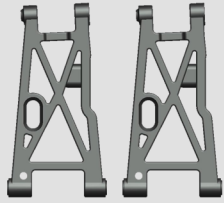
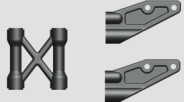
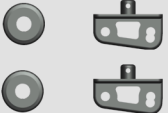





Список деталей

<p>10101 – Front Shock Tower 1pc</p>  <p>RH1006/RH1007/RH1016/RH1017</p>	<p>10102 –Rear Shock Tower 1pc</p>  <p>RH1006/RH1007/RH1016/RH1017</p>	<p>10001–Front Shocks 2pc</p>  <p>RH1006/RH1007/RH1016/RH1017</p>	<p>10002 – Rear Shock Tower 2pc</p>  <p>RH1006/RH1007/RH1016/RH1017</p>
<p>10103–Front Shock Spring 2pc</p>  <p>RH1006/RH1007/RH1016/RH1017</p>	<p>10104–Rear Shock Spring 2pc</p>  <p>RH1006/RH1007/RH1016/RH1017</p>	<p>10105–Front Shock Shaft & Piston Set 2sets</p>  <p>RH1006/RH1007/RH1016/RH1017</p>	<p>10106–Rear Shock Shaft & Piston Set 2sets</p>  <p>RH1006/RH1007/RH1016/RH1017</p>
<p>10107–Front Shock Body 2pc</p>  <p>RH1006/RH1007/RH1016/RH1017</p>	<p>10108–Rear Shock body 2pc</p>  <p>RH1006/RH1007/RH1016/RH1017</p>	<p>10109–Shock Upper Cap 2sets</p>  <p>RH1006/RH1007/RH1016/RH1017</p>	<p>10110–Shock Lower Caps 2sets</p>  <p>RH1006/RH1007/RH1016/RH1017</p>
<p>10111–Shock Lower holder & Adjust Ring 2sets</p>  <p>RH1006/RH1007/RH1016/RH1017</p>	<p>10114–Steering Knuckle Arm 1set</p>  <p>RH1006/RH1007/RH1016/RH1017</p>	<p>10115–Uprights 2pc</p>  <p>RH1006/RH1007/RH1016/RH1017</p>	<p>10117–Rear Hub Carrier 2pc</p>  <p>RH1006/RH1007/RH1016/RH1017</p>
<p>10118–Rear Drive Shaft 2pc</p>  <p>RH1006/RH1007/RH1016/RH1017</p>	<p>10120–Front Susp. Holders 2pc</p>  <p>RH1006/RH1007/RH1016/RH1017</p>	<p>10121–Rear Susp. Holders 2pc</p>  <p>RH1006/RH1007/RH1016/RH1017</p>	<p>10123–Gearbox Housing Set 2pcs</p>  <p>RH1006/RH1007/RH1016/RH1017</p>
<p>RH5526–Diff 16T Gear Washer 6pcs</p>  <p>RH1006/RH1007/RH1016/RH1017</p>	<p>10124–Diff. Drive Gear w/pin 2sets</p>  <p>RH1006/RH1007/RH1016/RH1017</p>	<p>10003–Diff Gearbox Set 1set</p>  <p>RH1006/RH1007/RH1016/RH1017</p>	<p>10125–Diff Case 2pcs</p>  <p>RH1006/RH1007/RH1016/RH1017</p>

Список деталей

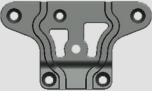
<p>10126-Diff Drive Spur Gear 2pcs</p>  <p>38T</p> <p>RH1006/RH1007/RH1016/RH1017</p>	<p>10127-Diff Drive Gear 2pcs</p>  <p>13T</p> <p>RH1006/RH1007/RH1016/RH1017</p>	<p>10128-Diff Bevel Gear S. 4pcs</p>  <p>10T</p> <p>RH1006/RH1007/RH1016/RH1017</p>	<p>10129-Diff Bevel Gear B. 4pcs</p>  <p>13T</p> <p>RH1006/RH1007/RH1016/RH1017</p>
<p>10130-Diff Pin 2pcs</p>  <p>RH1006/RH1007/RH1016/RH1017</p>	<p>10131-Washer 6pcs</p>  <p>RH1006/RH1007/RH1016/RH1017</p>	<p>10132-Diff Drive Cup 4pcs</p>  <p>RH1006/RH1007/RH1016/RH1017</p>	<p>10133-Center Coupler 3pcs</p>  <p>RH1006/RH1007/RH1016/RH1017</p>
<p>10135-Servo Saver (GP) 1set</p>  <p>RH1006/RH1007</p>	<p>10136-Servo Saver Post 2pcs</p>  <p>RH1006/RH1007/RH1016/RH1017</p>	<p>10137-Steering Ackerman</p>  <p>RH1006/RH1007/RH1016/RH1017</p>	<p>10145-Wheel Hub 4pcs</p>  <p>RH1006/RH1007/RH1016/RH1017</p>
<p>10146-Antenna Pipe Set 2sets</p>  <p>RH1006/RH1007/RH1016/RH1017</p>	<p>10147-Servo Saver (EP) 1set</p>  <p>RH1016/RH1017</p>	<p>10300-Front buggy tyre set 2sets</p>  <p>RH1006/RH1007/RH1016/RH1017</p>	<p>10301-Rear buggy tyre set 2sets</p>  <p>RH1006/RH1007/RH1016/RH1017</p>
<p>10302-Front buggy tyre set 2sets</p>  <p>RH1006/RH1007/RH1016/RH1017</p>	<p>10303-Rear buggy tyre set 2sets</p>  <p>RH1006/RH1007/RH1016/RH1017</p>	<p>10304-Front Rim 2pcs 10332-Rear Rim 2pcs</p>  <p>RH1006/RH1007/RH1016/RH1017</p>	<p>10305-Front tyres & inner foams 2sets</p>  <p>RH1006/RH1007/RH1016/RH1017</p>
<p>10306-Rear tyres & inner foams 2sets</p>  <p>RH1006/RH1007/RH1016/RH1017</p>	<p>10307-Front tyres & inner foams 2sets</p>  <p>RH1006/RH1007/RH1016/RH1017</p>	<p>10308-Rear tyres & inner foams 2sets</p>  <p>RH1006/RH1007/RH1016/RH1017</p>	<p>10309-Front CVD 2sets</p>  <p>RH1006/RH1007/RH1016/RH1017</p>

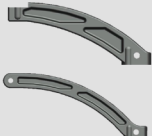
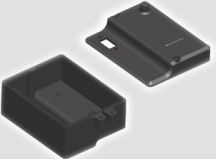









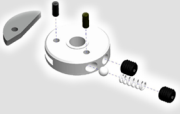



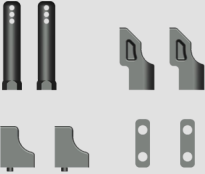



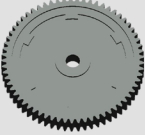

Список деталей

<p>10330-Chassis Front Part 1pc</p>  <p>RH1006/RH1007/RH1016/RH1017</p>	<p>10310-Front Bumper buggy 1pc</p>  <p>RH1006/RH1007/RH1016/RH1017</p>	<p>10311-Front Lower Susp. Arm 2pc</p>  <p>RH1006/RH1007/RH1016/RH1017</p>	<p>10312-Rear Lower Susp. Arm 2pc</p>  <p>RH1006/RH1007/RH1016/RH1017</p>
<p>10313-Wing Bracket 1set</p>  <p>RH1006/RH1007/RH1016/RH1017</p>	<p>10314-Wing Holder 1set</p>  <p>RH1006/RH1007/RH1016/RH1017</p>	<p>10315-Buggy Body Mount 1set</p>  <p>RH1006/RH1007/RH1016/RH1017</p>	<p>10316-Servo Linkage 1pc</p>  <p>10317-Front Upper Susp. Arm 2sets</p>  <p>RH1006/RH1007/RH1016/RH1017</p>
<p>10318-Rear Upper Susp. Arm 2sets</p>  <p>RH1006/RH1007/RH1016/RH1017</p>	<p>10319-Steering Arm 2sets</p>  <p>RH1006/RH1007/RH1016/RH1017</p>	<p>10320-Central Dongbone R. 1pc</p>  <p>RH1006/RH1007/RH1016/RH1017</p>	<p>10321-Chassis Plate Rear Part 1pc</p>  <p>RH1006/RH1007</p>
<p>10151-Manifold Gasket 6pc</p>  <p>RH1006/RH1007</p>	<p>10152-Metal Bushing 15*10*4 6pc</p> 	<p>10153-Metal Bushing 8*5*2.5 6pc</p> 	<p>10154-Servo & Upper Plate Mounts 1set</p>  <p>RH1006/RH1007</p>
<p>10156-Upper Plate 1pc</p>  <p>RH1006/RH1007</p>	<p>10157-Upper Steering Plate</p>  <p>RH1006/RH1007</p>	<p>10004-Fuel tank Set 1set</p>  <p>RH1006/RH1007</p>	<p>10158-Fuel Line 2pcs</p>  <p>RH1006/RH1007</p>
<p>10159-Front/Rear Chassis Brace</p>  <p>RH1006/RH1007</p>	<p>10160-Receiver Box 1set</p>  <p>RH1006/RH1007</p>	<p>85026-Switch Cover 2pcs</p>  <p>RH1006/RH1007</p>	<p>10161-Servo Horns</p>  <p>RH1006/RH1007</p>





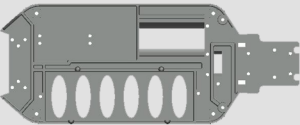
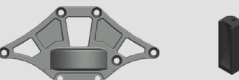
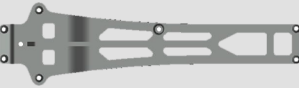











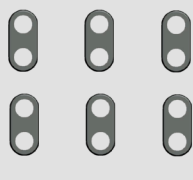

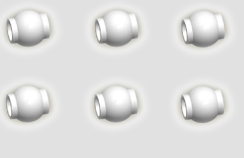
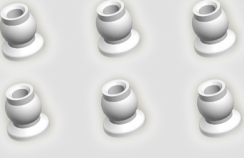

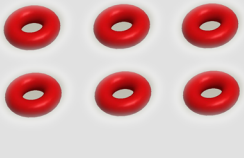
Список деталей

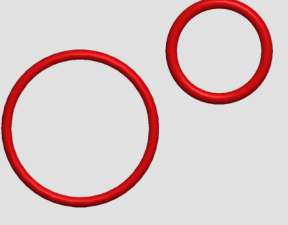
<p>10162-Chassis Brace mount 1pc</p>  <p>RH1006/RH1007</p>	<p>10163-Stopper 6pcs</p>  <p>RH1006/RH1007</p>	<p>10164-Throttle Linkage 1set</p>  <p>RH1006/RH1007</p>	<p>10165-Central Dongbone F. 1pc</p>  <p>RH1006/RH1007</p>
<p>P0010-GO. 18 engine 1pc P0011-SH. 18 Engine 1pc</p>  <p>RH1006/RH1007</p>	<p>10167-Air filter 1Set</p>  <p>RH1006/RH1007</p>	<p>10168-Tuned Pipe 1Set</p>  <p>RH1006/RH1007</p>	<p>10169-Silicone Coupler 1Set</p>  <p>RH1006/RH1007</p>
<p>85195-Zip Tie 6pcs</p>  <p>RH1001/RH1002/RH1011/RH1013</p>	<p>10170-Manifold 1Set</p>  <p>RH1006/RH1007</p>	<p>85035-Flywheel 1pc</p>  <p>RH1006/RH1007</p>	<p>85087-Clutch Nut 2pcs</p>  <p>RH1006/RH1007</p>
<p>85045-Clutch Shoes & Springs</p>  <p>RH1006/RH1007</p>	<p>10173-Engine mount 2pcs</p>  <p>RH1006/RH1007</p>	<p>10331-Clutch Bell (16T) 1pc</p>  <p>RH1006</p>	<p>10322-Clutch Bell (21T) 1pc</p>  <p>RH1007</p>
<p>10005-Central Transmission Complete 1Set (Single Speed)</p>  <p>RH1006</p>	<p>10174-Central Transmission Bulkheads 2pcs</p>  <p>RH1006/RH1007</p>	<p>10175-Brake Post 1Set</p>  <p>RH1006/RH1007</p>	<p>10176-Brake Set 1set</p>  <p>RH1006/RH1007</p>
<p>10177-Brake Cup 2pcs</p>  <p>RH1006/RH1007</p>	<p>10178-Single Speed Shaft w/pin</p>  <p>RH1006</p>	<p>10179-50T Gear (Single Speed) 1pc</p>  <p>RH1006</p>	<p>10006-Central Transmission Complete 1Set (Two Speed)</p>  <p>RH1007</p>





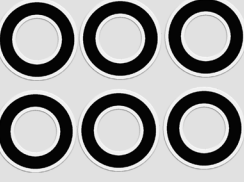













Список деталей

<p>10180-Two Speed Clutch 1Set</p>  <p>RH1007</p>	<p>10181-Two Speed Shaft 1pc</p>  <p>RH1007</p>	<p>10182-50T Two Speed Gear 1pc</p>  <p>RH1007</p>	<p>10183-45T Two Speed Gear 1pc</p>  <p>RH1007</p>
<p>10185-Battery Cover (EP) 1pc</p>  <p>RH1016/RH1017</p>	<p>10188-Battery Post 2sets</p>  <p>RH1016/RH1017</p>	<p>10189-Post for Rear Spur Gear Cover 2pc</p>  <p>RH1016/RH1017</p>	<p>10190-Motor Mount (EP) 1pc</p>  <p>RH1016/RH1017</p>
<p>10191-Slipper Complete (EP) 1set</p>  <p>RH1016/RH1017</p>	<p>10192-Slipper Pad (EP) 2pc</p>  <p>RH1016/RH1017</p>	<p>10193-Slipper Gasket (EP) 2pc</p>  <p>RH1016/RH1017</p>	<p>10194-65T Spur Gear (EP) 1pc</p>  <p>RH1016/RH1017</p>
<p>10195 - Slipper Shaft (EP) 1pc</p>  <p>RH1016/RH1017</p>	<p>10196-Slipper Spring Bracket (EP) 1pc</p>  <p>RH1016/RH1017</p>	<p>10197-Slipper Spring (EP) 1pc</p>  <p>RH1016/RH1017</p>	<p>10198-Slipper Coupler (EP) 1pc</p>  <p>RH1016/RH1017</p>
<p>10199-Slipper Drive Cup 1pc</p>  <p>RH1016/RH1017</p>	<p>10200-BEARING BRACKET (EP) 1pc</p>  <p>RH1016/RH1017</p>	<p>10323-Pinion Gear 23T (EP) 1pc</p>  <p>RH1016/RH1017</p>	<p>10324-Sway Bar 2Sets</p>  <p>RH1006/RH1007/RH1016/RH1017</p>
<p>10325-EP Chassiss plate 1pc</p>  <p>RH1016/RH1017</p>	<p>10326-Rear Spur Gear Cover (EP) 1pc</p>  <p>RH1016/RH1017</p>	<p>10327-Upper plate (EP) 1pc</p>  <p>RH1016/RH1017</p>	<p>10328-Center Drive Shaft (EP) 1pc</p>  <p>RH1016/RH1017</p>

Список деталей

<p>85034-Body Clip (Medium Size) 6pcs</p> 	<p>85029-Body Clip (Small Size) 6pcs</p> 	<p>10214-Shock Ball End 6pcs</p> 	<p>10215-Servo Link Ball End 6pcs</p> 
<p>10216-Steering Linkage Ball End 6pcs</p> 	<p>10217-Rear Upper Linkage Ball End 6pcs</p> 	<p>10218-Sway Bar Fix Plate 6pcs</p> 	<p>10219-Sway Bar Holders 6pcs</p> 
<p>10220-Ball A 6pcs</p> 	<p>10221-Ball B 6pcs</p> 	<p>10222-Ball C 6pcs</p> 	<p>10223-Ball D 6pcs</p> 
<p>10224-Shock O-ring (Lower) 6pcs</p> 	<p>10225-Diff O-ring Seal 6pcs</p> 	<p>10226-Shock O-ring (upper) 6pcs</p> 	<p>10227-Tuned Pipe Seal & Fuel Tank Seal 1set</p> 
<p>10228-Pin ϕ2*10 6pcs</p> 	<p>10229-Pin ϕ2*11 6pcs</p> 	<p>10329-Hinge Pins (long & short) 1sets</p> 	<p>10231-One Way Bearing 3pcs</p> 
<p>10232-Ball Bearing 15*10*4 6pcs</p> 	<p>10233-Ball Bearing 10*5*4 6pcs</p> 	<p>10234-Metal Bushing 10*5*4 6pcs</p> 	<p>10235-Ball Bearing 8*5*2.5 6pcs</p> 

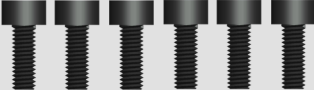
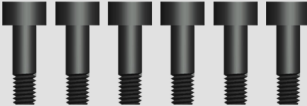
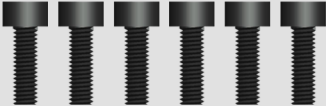
Список деталей

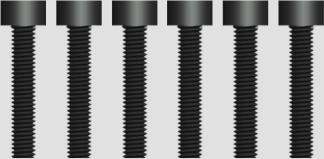
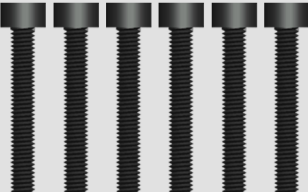
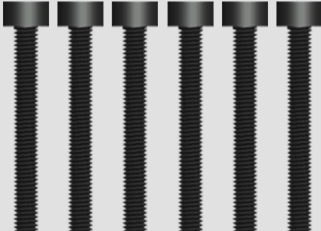
<p>10236-E clip-8mm 4pc</p> 	<p>RH5190-E clip-4mm 6pc</p> 	<p>10237-E clip-2.5mm 6pc</p> 	<p>RH5102-Nylon Lock Nut M3 6pc</p> 
<p>RH5103-Nylon Lock Nut-M4 6pc</p> 	<p>85148-Round Head Self Tapping Hex Screw 2*6 4pcs</p> 	<p>10238-Round Head Self Tapping Hex Screw 2*10 6pc</p> 	<p>85179-Round Head Self Tapping Hex Screw 3*15 8pc</p> 
<p>10239-Round Head Self Tapping Hex Screw M3*6 6pc</p> 	<p>10240-Button Head Hex Screw M3*8 6pc</p> 	<p>10241-Button Head Hex Screw M3*10 6pc</p> 	<p>85184-Button Head Hex Screw M3*12 6pc</p> 
<p>10242-Button Head Hex Screw M3*14 6pc</p> 	<p>85144-Ring Self Tapping Screw 3*4 4pc 10256-Ring Self Tapping Screw 3*6 6pc</p> 	<p>RH5116-Set Screw M3*3 6pc</p> 	<p>RH5117-Set Screw M4*4 6pc</p> 
<p>RH5118-Button Head Hex Screw M4*10 6pc</p> 	<p>RH5562-Cap Head Hex Screw M3*8 6pc</p> 	<p>10243-Cap Head Hex Screw M3*10 6pc</p> 	<p>85182-Cap Head Hex Screw M3*10 6pc</p> 
<p>10244-Cap Head Hex Screw M3*14 6pc</p> 	<p>85118-Cap Head Hex Screw M3*15 6pc</p> 	<p>10245-Cap Head Hex Screw M3*18 6pc</p> 	<p>85185-Cap Head Hex Screw M3*25 6pc</p> 

Список деталей

<p>10246-Cap Head Hex Screw M3*28 6p</p> 	<p>10247-Flat Head Hex M3*8 6pc</p> 	<p>85125-Flat Head Hex Screw M3*10 8p</p> 	<p>10248-Flat Head Hex Screw M3*12 6p</p> 
<p>10249-Flat Head Hex Screw M3*14 6p</p> 	<p>85127-Flat Head Hex Screw M3*18 3p</p> 	<p>10250-Flat Head Hex Screw M3*20 6p</p> 	<p>10251-Flat Head Hex Screw M3*36 6p</p> 
<p>H0013-AM Transmitter 1pc H0007-AM RX 1pc</p> 	<p>H0014 - 2.4GHz Transmitter 1pc</p> 	<p>H0026 - Brushless ESC 1pc</p> 	<p>H0027-300A ESC 1pc</p> 
<p>H0028 - 3650 Brushless Motor 1pc</p> 	<p>H0029 - 550 Brushed Motor 1pc</p> 	<p>H0030 - Ni-MH 7.2V 1800mAh 1pc H0031 - Ni-MH 7.2V 3000mAh 1pc</p> 	<p>H0012 - Battery Case 1pc RH5189 - Receiver Switch 1pc</p> 
<p>H0011 - 3kg/cm Servo 1pc</p> 	<p>R0068- Clear Body (GP) 1pc R0069- Clear Body (EP) 1pc</p> 	<p>R0070- Printed Body (GP) 1pc R0072- Printed Body (EP) 1pc</p> 	<p>R0071- Printed Body (GP) 1pc R0073- Printed Body (EP) 1pc</p> 
<p>R0074- Printed Body (EP) 1pc</p> 	<p>R0075-Buggy Tail Wing (Black) 1pc R0076-Buggy Tail Wing (Brown) 1pc R0077-Buggy Clear Tail Wing 1pc</p> 	<p>85274-Li-Po 2700mAh 7.4V 1pc</p> 	<p>10253 - 1/10 Charger CE 1pc 10254 - 1/10 Charger UL 1pc 10255 - 1/10 Charger BS 1pc</p> 

Список улучшенных деталей

<p>10902 – Front Shock Plate (Carbon) 1Set</p>  <p>RH1006/RH1007/RH1016/RH1017</p>	<p>10903 – Rear Shock Plate (Carbon) 1Set</p>  <p>RH1006/RH1007/RH1016/RH1017</p>	<p>10905–Battery Cover (Carbon) 1set</p>  <p>RH1016/RH1017</p>	<p>10906–Body Post (AL) 2pc</p>  <p>RH1016/RH1017</p>
<p>10907–Front Shocks (AL) 2pc</p>  <p>RH1006/RH1007/RH1016/RH1017</p>	<p>10908–Rear Shocks (AL) 2pc</p>  <p>RH1006/RH1007/RH1016/RH1017</p>	<p>10911 – Steering Ackerman (AL) 1pc</p>  <p>RH1006/RH1007/RH1016/RH1017</p>	<p>10912 – Front Susp. Holders (AL) 1Set</p>  <p>RH1006/RH1007/RH1016/RH1017</p>
<p>10913 – Front & Rear Brace(AL) 1Set</p>  <p>RH1006/RH1007</p>	<p>10914 – Rear Susp. Holders (AL) 1Set</p>  <p>RH1006/RH1007/RH1016/RH1017</p>	<p>10915 – Rear Hub Carrier (AL) 2pc</p>  <p>RH1006/RH1007/RH1016/RH1017</p>	<p>10916–Front Top Plate (Carbon) 1pc</p>  <p>RH1006/RH1007</p>
<p>10917 – Steering Knuckle Arm (AL) 2Set</p>  <p>RH1006/RH1007/RH1016/RH1017</p>	<p>10918 – Wheel Hub (AL) 4pc</p>  <p>RH1006/RH1007/RH1016/RH1017</p>	<p>10919 – Upper Plate (AL) 1pc</p>  <p>RH1006/RH1007</p>	<p>10920 – Tuned Pipe(AL) 1Set</p>  <p>RH1006/RH1007</p>
<p>10921 – Chassis Brace mount (AL) 1pc</p>  <p>RH1006/RH1007</p>	<p>10922 – Wheelie Set 1Set</p>  <p>RH1006/RH1007/RH1016/RH1017</p>	<p>10923 – Alum Steering Arm 2pc</p>  <p>RH1006/RH1007/RH1016/RH1017</p>	<p>10924 – Alum Knuckle Arm 2pc</p>  <p>RH1006/RH1007/RH1016/RH1017</p>
<p>85265 – Heatsink 1pc</p>  <p>RH1016/RH1017</p>	<p>10925–Chassis Plate (AL+Carbon) 1Set</p>  <p>RH1016/RH1017</p>	<p>10926–Upper Plate (Carbon) 1pc</p>  <p>RH1016/RH1017</p>	<p>10927–Front Lower Susp. Arm (AL) 2pc</p>  <p>RH1006/RH1007/RH1016/RH1017</p>
<p>10928–Rear Lower Susp. Arm (AL) 2pc</p>  <p>RH1006/RH1007/RH1016/RH1017</p>			